

AKAI SERVICE MANUAL

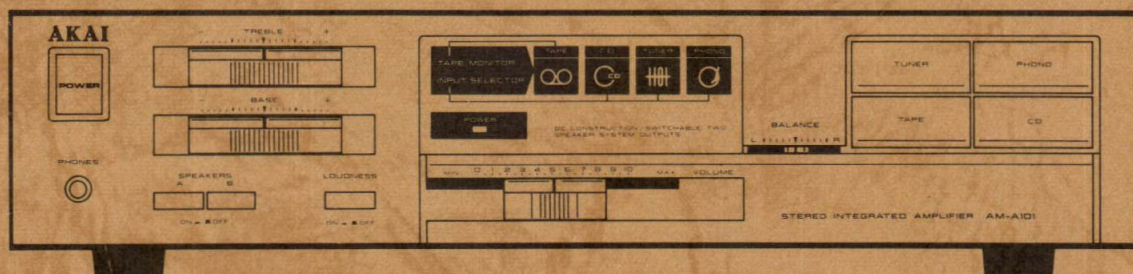

STEREO INTEGRATED AMPLIFIER

MODEL **AM-A101**



STEREO INTEGRATED AMPLIFIER

MODEL **AM-A101**

SECTION 1	SERVICE MANUAL	3
SECTION 2	PARTS LIST	9

SAFETY INSTRUCTIONS

SAFETY CHECK AFTER SERVICING

Confirm the specified insulation resistance between power cord plug prongs and externally exposed parts of the set is greater than 10 Mohms, but for equipment with external antenna terminals (tuner, receiver, etc.) and is intended for **C** or **A**, specified insulation resistance should be more than 2.2 Mohms (ground terminals, microphone jacks, headphone jacks, line-in-out jacks etc.)

PRECAUTIONS DURING SERVICING

1. Parts identified by the Δ symbol parts are critical for safety.
Replace only with parts number specified.
2. In addition to safety, other parts and assemblies are specified for conformance with such regulations as those applying to spurious radiation. These must also be replaced only with specified replacements.
Examples: RF converters, tuner units, antenna selector switches, RF cables, noise blocking capacitors, noise blocking filters, etc.
3. Use specified internal wiring. Note especially:
 - 1) Wires covered with PVC tubing
 - 2) Double insulated wires
 - 3) High voltage leads
4. Use specified insulating materials for hazardous live parts. Note especially:
 - 1) Insulation Tape
 - 2) PVC tubing
 - 3) Spacers (Insulating Barriers)
 - 4) Insulation sheets for transistors
 - 5) Plastic screws for fixing microswitch (especially in turntable)
5. When replacing AC primary side components (transformers, power cords, noise blocking capacitors, etc.), wrap ends of wires securely about the terminals before soldering.

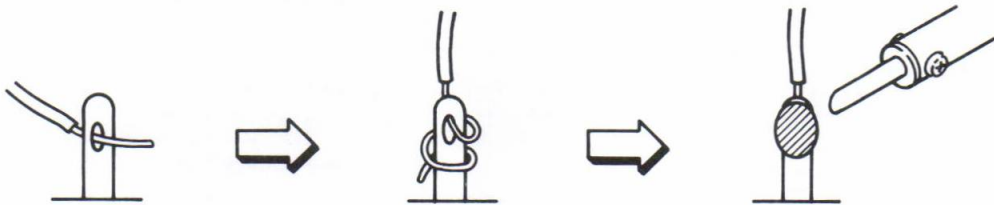

6. Observe that wires do not contact heat producing parts (heatsinks, oxide metal film resistors, fusible resistors, etc.).
7. Check that replaced wires do not contact sharp edged or pointed parts.
8. Also check areas surrounding repaired locations.
9. Use care that foreign objects (screws, solder droplets, etc.) do not remain inside the set.

VOLTAGE CONVERSION

Models for Canada, USA, Europe, UK and Australia are not equipped with this facility. Each machine is preset at the factory according to destination, but some machines can be set to 110V, 120V, 220V or 240V as required. If your machine's voltage can be converted: Before connecting the power cord, turn the VOLTAGE SELECTOR located on the rear panel with a screwdriver until the correct voltage is indicated.

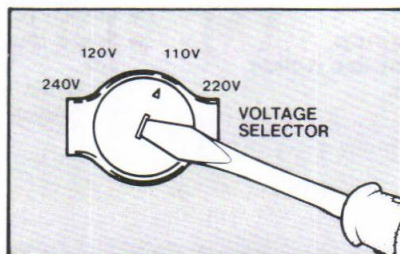

SECTION 1

SERVICE MANUAL

TABLE OF CONTENTS

I. SPECIFICATIONS	4
II. DISMANTLING OF UNIT	5
III. CONTROLS	6
IV. PRINCIPAL PART LOCATION	7
V. PC BOARD TITLES AND IDENTIFICATION NUMBERS	8

For basic adjustments, measuring methods, and operating principles, refer to GENERAL TECHNICAL MANUAL.

I. SPECIFICATIONS

POWER AMPLIFIER SECTION

RATED POWER OUTPUT 40Hz to 20kHz	8 ohms 25W/0.3%
POWER OUTPUT (BY FTC) 40Hz to 200kHz DIN 1kHz	25W/0.3% 30W/0.3%
MUSIC POWERS (BOTH CHANNEL)	160W
POWER BANDWIDTH (IHF -3dB, 8 ohms)	10Hz to 40kHz (0.5%)
S/N (IHF-A) PHONO AUX	72dB 95dB
RESIDUAL NOISE (8 ohms)	0.5mV
CHANNEL SEPARATION (IHF, 1kHz)	45dB
DAMPING FACTOR (1kHz, 8 ohms)	30
REQUIRED SPEAKER IMPEDANCE FOR WEST GERMANY, UK and AUSTRALIA FOR OTHER COUNTRIES	A or B: 4 to 16 ohms A and B: 4 to 16 ohms A or B: 6 to 16 ohms A and B: 6 to 16 ohms

PRE-AMPLIFIER SECTION

INPUT SENSITIVITY/IMPEDANCE PHONO AUX TUNER TAPE	2.5mV/47k ohms 150mV/47k ohms 150mV/47k ohms 150mV/47k ohms
OUTPUT LEVEL/IMPEDANCE TAPE REC	150mV/1k ohms
FREQUENCY RESPONSE PHONO (RIAA DEVIATION) TUNER, AUX, TAPE	±0.5dB 5Hz to 100kHz (-3dB)
TONE CONTROL BASS TREBLE	±8dB ±8dB
PHONO MAX. INPUT LEVEL	120mV
POWER REQUIREMENTS	120V,60Hz for USA & Canada 220V,50Hz for Europe except UK 240V,50Hz for UK & Australia 110/120/220/240V,50/60Hz convertible for other countries
DIMENSIONS	440(W) × 100(H) × 267(D)mm (17.3 × 3.9 × 10.5 inches)
WEIGHT	5.3kg (11.7 lbs)

* For improvement purposes, specifications and design are subject to change without notice.

II. DISMANTLING OF UNIT

In case of trouble, etc. necessitating dismantling, please dismantle in the order shown in the photographs. Reassemble in reverse order.

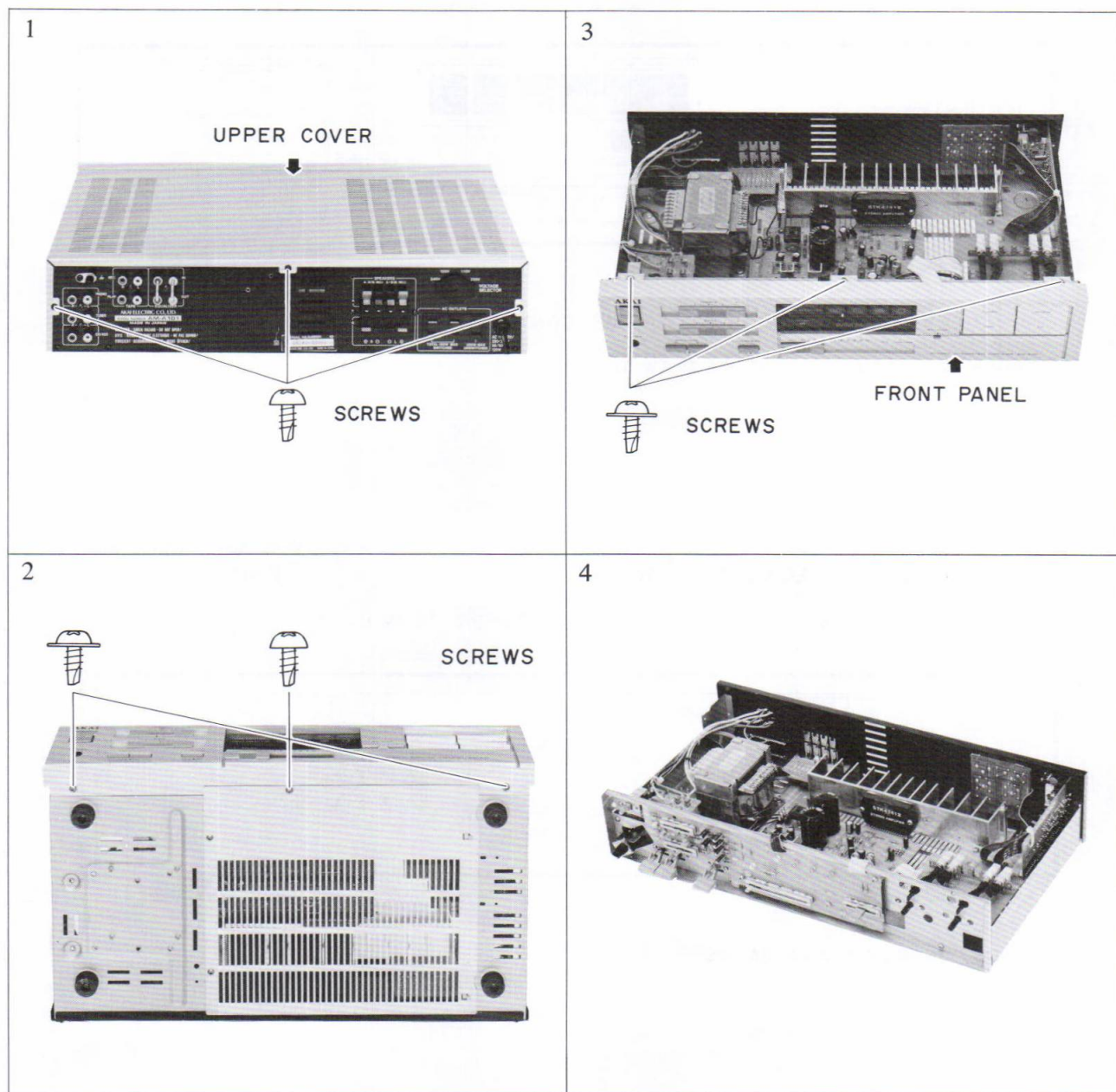

III. CONTROLS

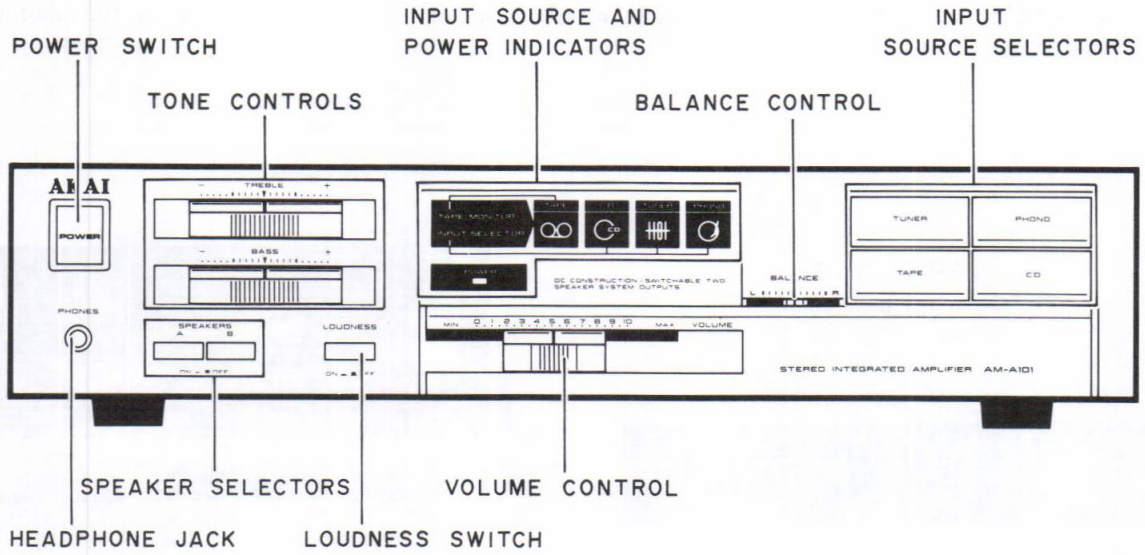

Fig. 3-1

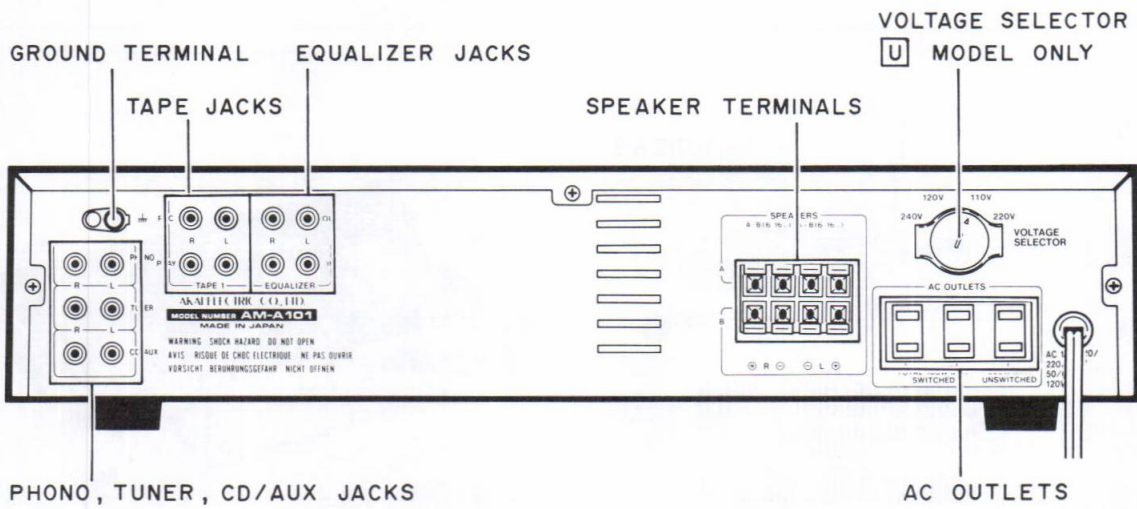

Fig. 3-2

IV. PRINCIPAL PART LOCATION

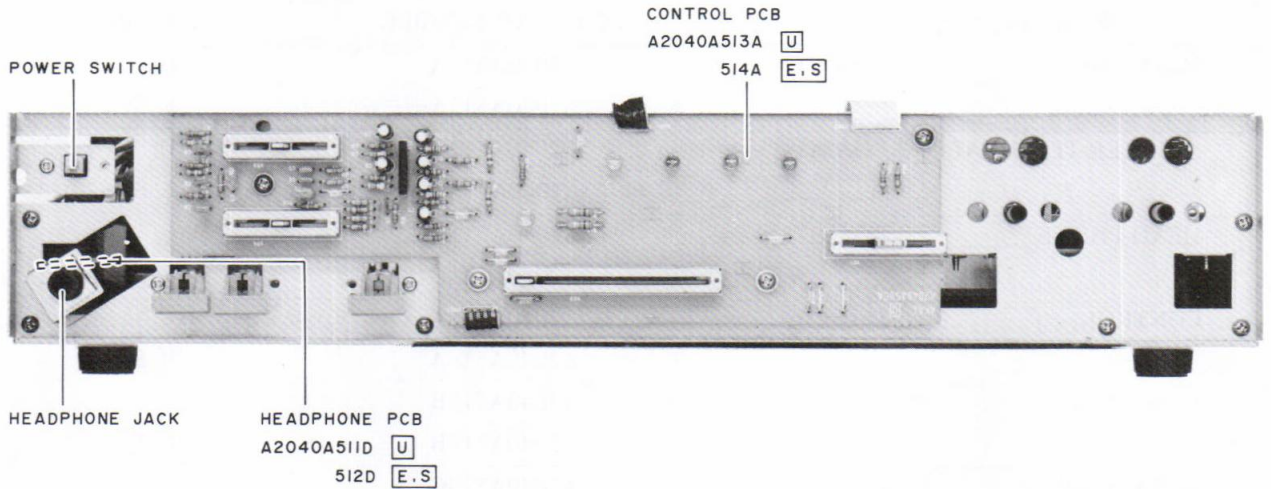

Fig. 4-1

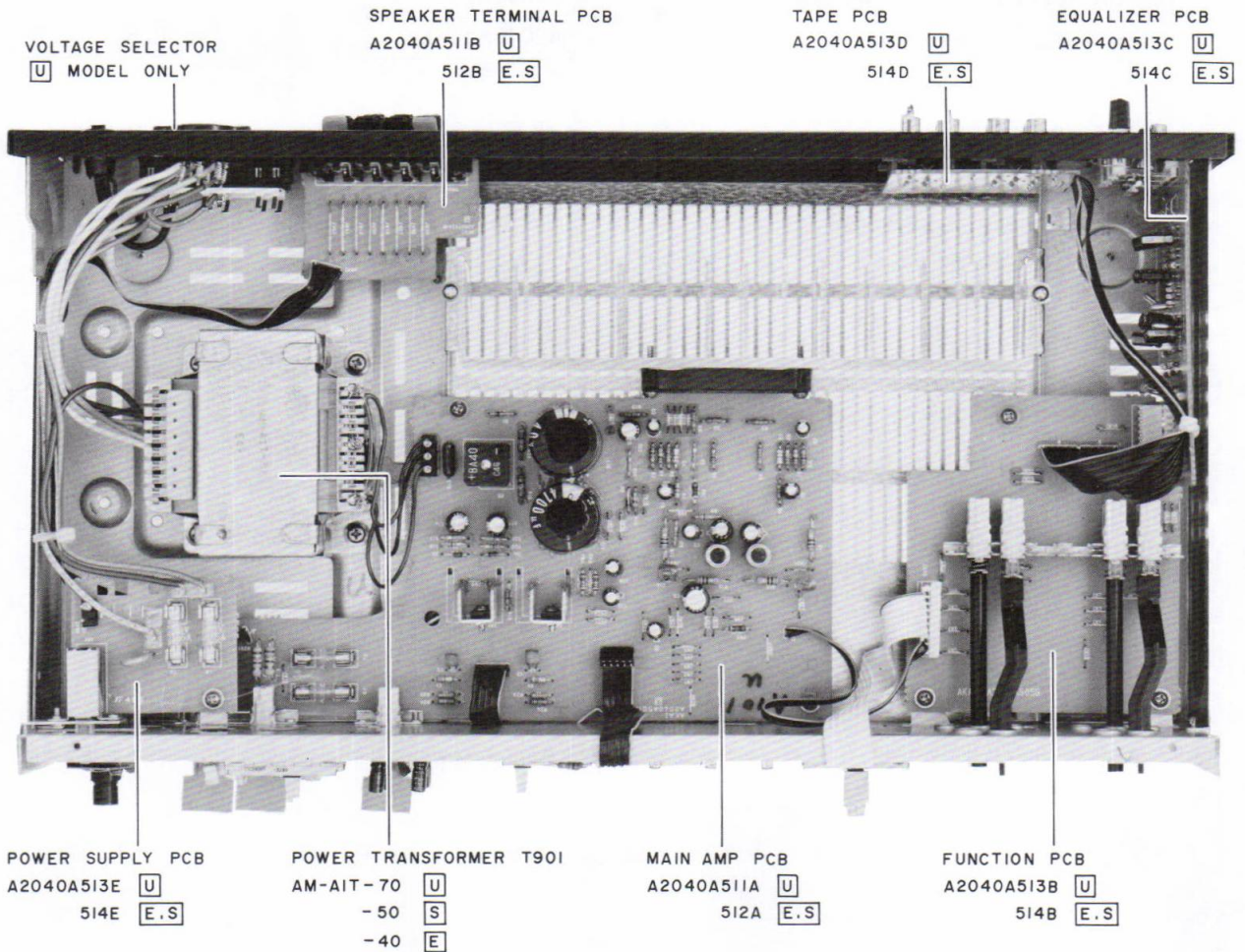

Fig. 4-2

V. PC BOARD TITLES AND IDENTIFICATION NUMBERS

PC BOARD TITLE		PC BOARD NUMBER	REMARKS
MAIN AMP	PC BOARD	A2040A511A	U
		A2040A512A	E, S
SPEAKER TERMINAL	PC BOARD	A2040A511B	U
		A2040A512B	E, S
HEAD PHONE	PC BOARD	A2040A511D	U
		A2040A512D	E, S
CONTROL	PC BOARD	A2040A513A	U
		A2040A514A	E, S
FUNCTION	PC BOARD	A2040A513B	U
		A2040A514B	E, S
EQUALIZER	PC BOARD	A2040A513C	U
		A2040A514C	E, S
TAPE	PC BOARD	A2040A513D	U
		A2040A514D	E, S
POWER SUPPLY	PC BOARD	A2040A513E	U
		A2040A514E	E, S

SECTION 2

PARTS LIST

TABLE OF CONTENTS

RECOMMENDED SPARE PARTS	11
1. PC BOARD BLOCK	12
2. MAIN AMP PC BOARD	12
3. CONTROL PC BOARD	12
4. EQUALIZER PC BOARD	12
5. FUNCTION PC BOARD	12
6. TAPE PC BOARD	12
7. HEAD PHONE PC BOARD	12
8. SPEAKER PC BOARD	12
9. POWER SUPPLY PC BOARD	12
10. ASSEMBLY BLOCK	13
11. FINAL ASSEMBLY BLOCK	14
INDEX	15

Resistor and Capacitor which is not listed in this parts list, please refer to COMMON LIST FOR SERVICE PARTS.

ATTENTION

1. When placing an order for parts, be sure to list the parts no. model no., and description of each part. If any of this information is omitted, there are instances in which parts cannot be shipped or the wrong parts will be delivered.
2. Please be careful not to make a mistake in the parts no. If the parts no. is in error, a part different from the one ordered may be delivered.
3. Because part numbers and part definitions and supply in the Preliminary Parts List may have been the subject of changes, please use this parts list for all future reference.

HOW TO USE THIS PARTS LIST

1. This Parts List shows those parts which are considered necessary for repairs. Other parts, such as resistors and capacitors, are shown in the "Common List for Service Parts" from which these parts should be selected and parts.
2. The Recommended Spare Parts List shows those parts in the Parts List which are considered particularly important for service.
3. Parts not shown in the Parts List and "Common List for Service Parts" will not in principle be supplied.
4. How to read the parts list

a) Mechanism Block

b) P.C Board Block

2. HEAD BASE BLOCK

REF. NO.	PART NO.	DESCRIPTION
2-1 ^x	BH-T2023A320A	HEAD BASE BLOCK GX-F66R
2-2	HP-H2206A010A	HEAD R/P PR4-8FU C
2-3	ZS-477876	PAN20x03STL CMT
2-4	ZS-536488	BID20x08STL CMT
2-5	ZG-402895	CS ANGLE ADJUST SPRING

SP (Service Parts) Classification

A small "x" indicates the inability to show that particular part in the Photo or Illustration.

This number corresponds with the individual parts index number in that figure

This number corresponds with the Figure Number

6. SYS. CON. P C BOARD BLOCK

REF. NO.	PART NO.	DESCRIPTION
6-1	BA-T2034A070A	PC SYS CON BLK GX-F44R
6-1C1	EI-324536	IC HD14049BP
6-1C2	EI-336801	IC MB8841-564M
6-1C3	EI-331661	IC SN7405N
6-1C4	EI-336725	IC M54527P
6-TR1to4	ET-200985	TR 2SC2603 F,G
6-TR5to28	ET-554657	TR 2SA733A P,Q
6-D1	ED-318292	D SILICON H 1S2473T-77 T26
6-D2to4	ED-308952	D GERMA V 1K34A-LR F07
6-D5to10	ED-318292	D SILICON H 1S2473T-77 T26
6-X1	EI-318384	OSC X'TAL NC-18C 3.579545MHZ

SP (Service Parts) Classification

These reference symbols correspond with component symbols in the Schematic Diagrams.

5. The kind of part and its installation position can both be determined by the Part Number. To determine where a part number is listed, utilize the Parts Index at the end of the Parts List. It is necessary first of all to find the Part Number. This can be accomplished by using the Reference Number listed at the right of the part number in the Parts Index.

WARNING

△ INDICATES SAFETY CRITICAL COMPONENTS. FOR CONTINUED SAFETY, REPLACE SAFETY CRITICAL COMPONENTS ONLY WITH MANUFACTURE'S RECOMMENDED PARTS

AVERTISSEMENT

△ IL INDIQUE LES COMPOSANTS CRITIQUES DE SÉCURITÉ. POUR MAINTENIR LE DEGRÉ DE SÉCURITÉ DE L'APPAREIL, NE REMPLACER QUE DES PIÈCES RECOMMANDÉES PAR LE FABRICANT

RECOMMENDED SPARE PARTS

Because, if the parts listed below are on hand, almost any repair can be accomplished, we suggest that you stock these Recommended Spare Parts Items.

REF. NO.	PART NO.	DESCRIPTION
1	BT-352430	△ TRANS POWER AM-A1T-40 [E]
2	BT-352431	△ TRANS POWER AM-A1T-50 [S]
3	BT-352426	△ TRANS POWER AM-A1T-70 [U]
4	ED-200213	△ D SILICON DBA40C-K15 200/2.6A
5	ED-301911	△ D SILICON H DS448
6	ED-306320	△ D ZENER H HZ15 2
7	ED-329056	△ D ZENER H HZ22 2
8	ED-355605	D LED AY5525S AMBER
9 N	ED-356424	D LED BG5525S GREEN
10 N	ED-356421	D LED BR5505S RED
11	ED-348205	D SILICON V MC931 DOUBLE
12	EF-602550	△ FUSE SEMKO T 1.25A 250V [E,S]
13	EF-623125	△ FUSE SEMKO T 250V 2.50A [E,S]
14	EF-311839	△ FUSE TSC A 250V 1.60A [U]
15	EF-326639	△ FUSE TSC A 250V 3.15A [U]
16	EI-337228	IC M5218L0
17	EI-344764	IC M5218P-21
18	EI-352644	IC STK4141(2)
19	ER-318647	△ R FUSE ERD2FC S10 1/4W 4R7J
20	ER-328278	△ R FUSE ERD2FC 1/4W 10R0G
21	ER-200746	△ R FUSE ERD2FC 1/4W 1000G
22	ES-337902	△ SW PUSH SDDL1P002 01-1
23	ES-349070	△ SW SELECTOR YKS11-0002 02-4 [U]
24 N	ES-358556	SW PUSH ESB-621519 2 THROW
25 N	ES-358555	SW PUSH ESB-62672 2-02-02S
26 N	ES-358537	SW PUSH ESB-62968 4THROW
27	ET-322598	△ TR 2SB632K E,F
28	ET-310148	△ TR 2SD612K E,F
29 N	EV-358539	VR SLIDE 25P1SVOF W105
30 N	EV-358541	VR SLIDE 25P2SV C104
31 N	EV-358563	VR SLIDE 60P2SVOM B254

“NOTE”: N: New Parts

SYMBOL FOR DESTINATION

[E] : CEE (Europe)

[S] : SAA (Australia)

[U] : U/T (Universal Area)

1. PC BOARD BLOCK

REF. NO.	PART NO.	DESCRIPTION
1-1A	BA-A2040A020E	PC MAIN BLK AM-A101 (U)
1-1B	BA-A2040A020F	PC MAIN BLK AM-A101 (E,S)
1-2A	BA-A2040A030E	PC CONTROL BLK AM-A101(U)
1-2B	BA-A2040A030F	PC CONTROL BLK AM-A101(E,S)

NOTES (1) PC MAIN BLK consists of following PC BOARDS

- MAIN AMP PC BOARD
- HEAD PHONE PC BOARD
- SPEAKER PC BOARD

(2) PC CONTROL BLK consists of following PC BOARDS

- CONTROL PC BOARD
- EQUALIZER PC BOARD
- FUNCTION PC BOARD
- TAPE PC BOARD
- POWER SUPPLY PC BOARD

2. MAIN AMP PC BOARD

REF. NO.	PART NO.	DESCRIPTION
MAIN AMP PC BOARD		
2-TR1	ET-310148	△ TR 2SD612K E,F
2-TR2	ET-322598	△ TR 2SB632K E,F
2-D1	ED-301911	△ D SILICON H DS448
2-D2	ED-329056	△ D ZENER H HZ22 2
2-D3,D4	ED-306320	△ D ZENER H HZ15 2
2-D5	ED-200213	△ D SILICON DBA40C-K15 200/2.6A
2-SW1	ES-358555	SW PUSH ESB-62672 2-02-02S
2-SW2	ES-358556	SW PUSH ESB-621519 2 THROW
2-L1	EO-337880	COIL FIX 2 202AK-018 2R2K
2-FR1	ER-328278	△ R FUSE ERD2FC 1/4W 10R0G
2-FR2	ER-200746	△ R FUSE ERD2FC 1/4W 1000G
2-FR3,FR4	ER-318647	△ R FUSE ERD2FC S10 1/4W 4R7J
2-R7	ER-325269	△ R CB H S10 FS RDS 1/4W 222J
2-R9	ER-333355	△ R CB H S10 FS RDS 1/4W 103J
2-R10,R11	ER-308875	△ R CB H S15 FS RDS 1/2W 100J
2-R12	ER-308028	△ R OMF H S15 FS 1W 181J
2-R15	ER-328082	△ R CB H S10 FS RDS 1/4W 332J
2-R16	ER-353214	R CB H RD 1/2W 103J
2-R17	ER-328082	△ R CB H S10 FS RDS 1/4W 332J
2-R18	ER-323074	△ R CB H S10 FS RDS 1/4W 102J
2-R19	ER-355633	△ R OMF H S15 FS 1W 331J
2-R20	ER-353214	R CB H RD 1/2W 103J
2-R21	ER-328082	△ R CB H S10 FS RDS 1/4W 332J
2-R22	ER-323074	△ R CB H S10 FS RDS 1/4W 102J
2-C13	EC-352643	C EC V 472M 40DC

2-C16	EC-352643	C EC V 472M 40DC
2-C19	EC-326583	C MMY V CUT CF921 473K 400DC

ASSEMBLY BLOCK

2-IC1	EI-352644	IC STK4141(2)
2-F3A	EF-326639	△ FUSE TSC A 250V 3.15A [U]
2-F3B	EF-623125	△ FUSE SEMKO T 250V 2.50A [E,S]
2-F4A	EF-326639	△ FUSE TSC A 250V 3.15A [U]
2-F4B	EF-623125	△ FUSE SEMKO T 250V 2.50A [E,S]

3. CONTROL PC BOARD

REF. NO.	PART NO.	DESCRIPTION
3-IC1	EI-337228	IC M5218L0
3-D1 to D3	ED-356424	D LED BG5525S GREEN
3-D4	ED-355605	D LED AY5525S AMBER
3-D5	ED-356421	D LED BR5505S RED
3-D6	ED-348205	D SILICON V MC931 DOUBLE
3-VR1	EV-358539	VR SLIDE 25P1SVOF W105
3-VR2	EV-358563	VR SLIDE 60P2SVOM B254
3-VR3,VR4	EV-358541	VR SLIDE 25P2SV C104
3-R15,R16	ER-333598	△ R CB H S15 FS RDS 1/2W 102J

4. EQUALIZER PC BOARD

REF. NO.	PART NO.	DESCRIPTION
4-IC1	EI-344764	IC M5218P-21
4-R7	ER-355214	△ R OMF H S15 FS RSM 2W 151J
4-J1	EJ-336904	PIN J AJC-036-ACB P 6P

5. FUNCTION PC BOARD

REF. NO.	PART NO.	DESCRIPTION
5-SW1	ES-358537	SW PUSH ESB-62968 4 THROW

6. TAPE PC BOARD

REF. NO.	PART NO.	DESCRIPTION
6-J1,J2	EJ-343365	PIN J YMC21-0063 P 4P

7. HEAD PHONE PC BOARD

REF. NO.	PART NO.	DESCRIPTION
7-J1	EJ-358535	PHONE J 3P M1669-ACCB 6.3

8. SPEAKER PC BOARD

REF. NO.	PART NO.	DESCRIPTION
8-TM902	EJ-349401	TERMINAL LEVER YKD21-0027 8P

9. POWER SUPPLY PC BOARD

REF. NO.	PART NO.	DESCRIPTION
POWER SUPPLY PC BOARD		
9-C1A	EC-320548	△ C CE V F 103Z 250AC [U]
9-C1B	EC-338496	△ C CE V FZ 472P 400AC [E,S]
9-SW1	ES-337902	△ SW PUSH SDDL1P002 01-1
ASSEMBLY BLOCK		
9-F1A	EF-311839	△ FUSE TSC A 250V 1.60A [U]
9-F1B	EF-602550	△ FUSE SEMKO T 1.25A 250V [E,S]
9-F2	EF-311839	△ FUSE TSC A 250V 1.60A [U]

ASSEMBLY BLOCK

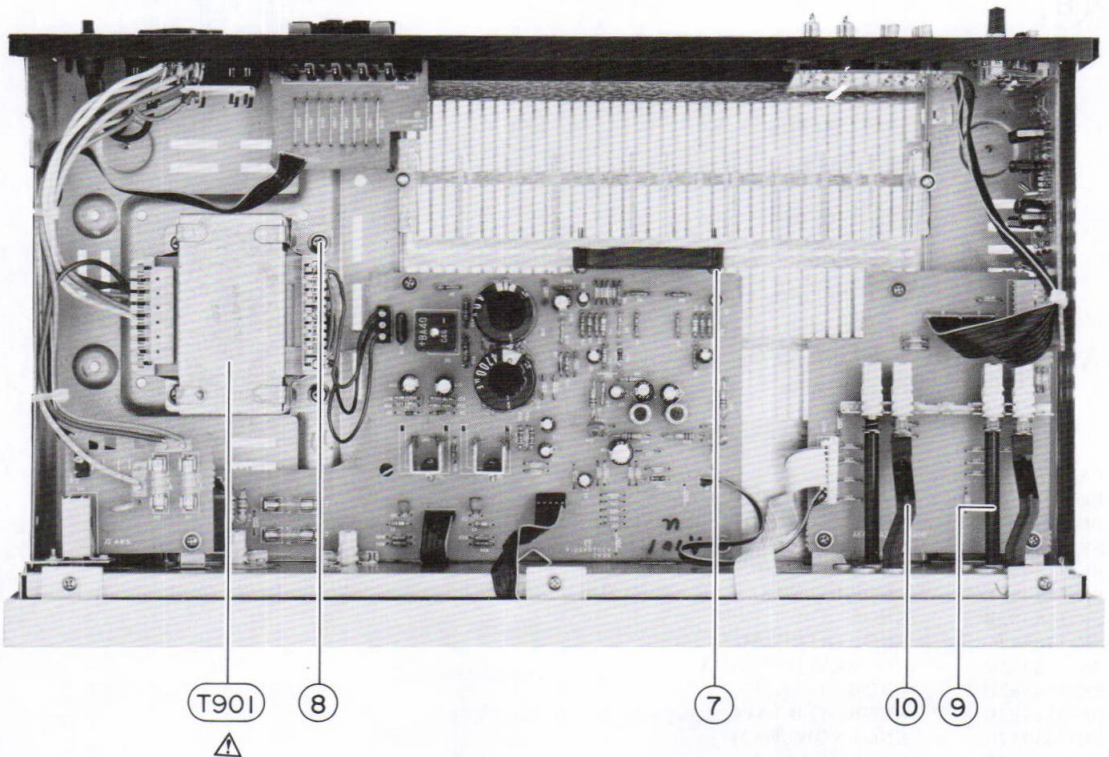
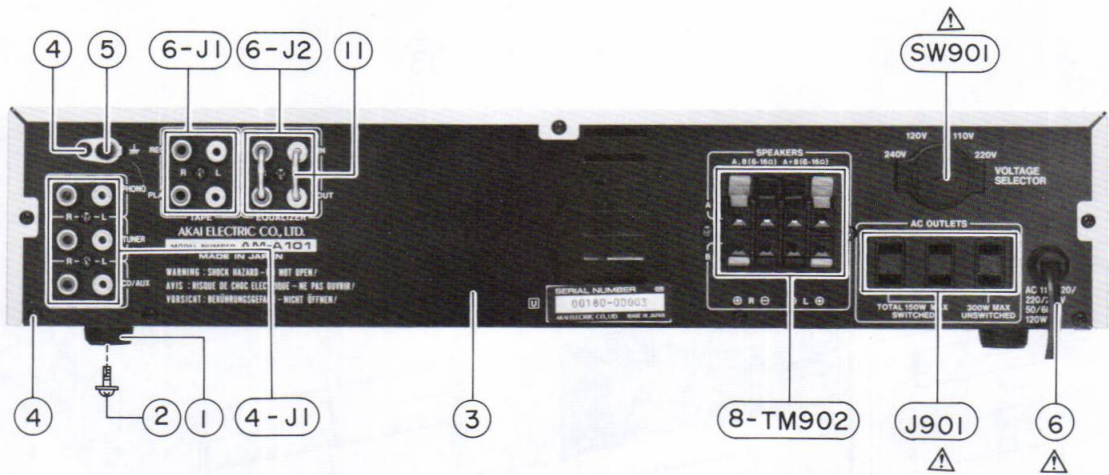

10. ASSEMBLY BLOCK

REF. NO.	PART NO.	DESCRIPTION
	ASSEMBLY BLOCK	
10-1	SA-332850	ROUND FOOT
10-2	ZS-331567	T2BR30x08STL CMT C080
10-3A	SP-358485J	PANEL REAR AM-A101(U)
10-3B	SP-358485K	PANEL REAR AM-A101(E)
10-3C	SP-358485L	PANEL REAR AM-A101(S)
10-4	ZS-308846	T2BR30x08STL BZN PROJECTION
10-5	EJ-329610	TERMINAL W/SCREW UB-0067 L 1P
10-6A	EW-354515	△ AC CORD 2 CORES KP-700A, VFF-CB U/T [U]
10-6B	EW-354625	△ AC CORD 2 CORES KP-419C, LTCE-2F E [E]
10-6C	EW-354514	△ AC CORD 2 CORES KP-560, LTSA2F-CB S [S]
10-7	ZS-321279	T2BR30x18STL CMT
10-8	ZS-346742	ST BID40x08STL CMT CUP
10-9	TA-358475	JOINT (A)
10-10	TA-358473B	JOINT (B)-2
10-11	EJ-348218	PLUG SHORT PIN P2138
10-T901A	BT-352426	△ TRANS POWER AM-A1T-70 [U]
10-T901B	BT-352430	△ TRANS POWER AM-A1T-40 [E]
10-T901C	BT-352431	△ TRANS POWER AM-A1T-50 [S]
10-SW901	ES-349070	△ SW SELECTOR YKS11-0002 02-4 [U]
10-J901	EJ-337405	△ SOCKET OUTLET S2T733T164 JUC 3x2P [U]
4-J1	EJ-336904	PIN J AJC-036-ACB P 6P
6-J1, J2	EJ-343365	PIN J YMC21-0063 P 4P
8-TM902	EJ-349401	TERMINAL LEVER YKD21-0027 8P

FINAL ASSEMBLY BLOCK

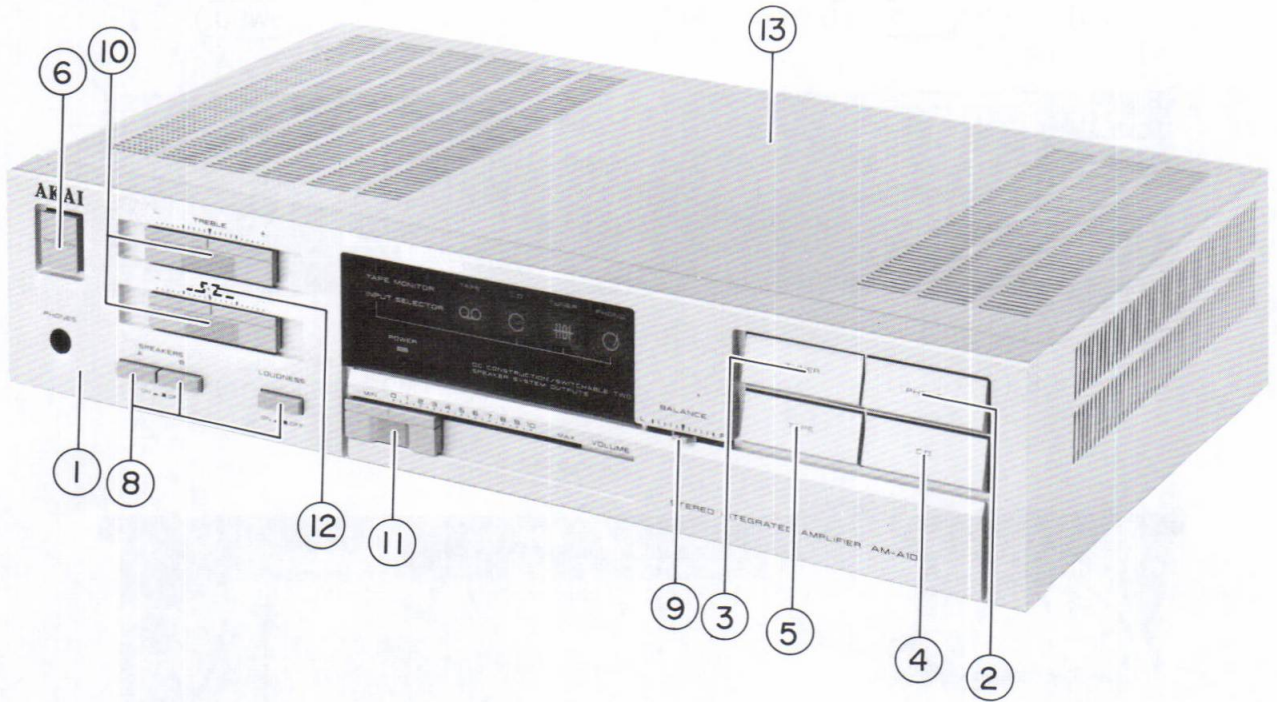

11. FINAL ASSEMBLY BLOCK

REF. NO.	PART NO.	DESCRIPTION
PANEL FRONT BLOCK		
11-1	BD-A2040A040C	PANEL FRONT BLK AM-A101
11-1B	BD-A2040A040D	PANEL FRONT BLK AM-A101-B
11-2	SK-358482E	KNOB (A) PHONO
11-2B	SK-358482A	KNOB (A)-B PHONO
11-3	SK-358482F	KNOB (A) TUNER
11-3B	SK-358482B	KNOB (A)-B TUNER
11-4	SK-358482G	KNOB (A) CD/AUX
11-4B	SK-358482C	KNOB (A)-B CD/AUX
11-5	SK-358482H	KNOB (A) TAPE
11-5B	SK-358482D	KNOB (A)-B TAPE
11-6	SK-343017C	KNOB POWER (2)
11-6B	SK-343017F	KNOB POWER -B
FINAL ASSEMBLY BLOCK		
11-7x	ZS-498273	T2BR30 x08STL CMT PW080 [PANEL FRONT FIX]
11-8	SK-358479B	KNOB (F-2)
11-8B	SK-358479A	KNOB (F-1)
11-9	SK-358477B	KNOB (C-2)
11-9B	SK-358477A	KNOB (C-1)
11-10	SK-358480B	KNOB (E-2)
11-10B	SK-358480A	KNOB (E-1)
11-11	SK-358474B	KNOB (D-2)
11-11B	SK-358474A	KNOB (D-1)
11-12	ZG-360943	SP TONE
11-13	SP-349925A	COVER UPPER
11-13B	SP-349925C	COVER UPPER-B

NOTES:

PANEL FRONT BLK consists of 11-2 to 11-6B.

SYMBOL FOR COLOR VARIATION

NON: STANDARD COLOR

B or BL: BLACK

INDEX

PART NO.	REF. NO.	PART NO.	REF. NO.	PART NO.	REF. NO.	PART NO.	REF. NO.	PART NO.	REF. NO.
BA-A2040A020E	1-1A	SK-358474A	11-11B						
BA-A2040A020F	1-1B	SK-358474B	11-11						
BA-A2040A030E	1-2A	SK-358477A	11-9B						
BA-A2040A030F	1-2B	SK-358477B	11-9						
BD-A2040A040C	11-1	SK-358479A	11-8B						
BD-A2040A040D	11-1B	SK-358479B	11-8						
BT-352426	10-T901A	SK-358480A	11-10B						
BT-352430	10-T901B	SK-358480B	11-10						
BT-352431	10-T901C	SK-358482A	11-2B						
EC-320548	9-C1A	SK-358482B	11-3B						
EC-326583	2-C19	SK-358482C	11-4B						
EC-338496	9-C1B	SK-358482D	11-5B						
EC-352643	2-C16	SK-358482E	11-2						
EC-352643	2-C13	SK-358482F	11-3						
ED-200213	2-D5	SK-358482G	11-4						
ED-301911	2-D1	SK-358482H	11-5						
ED-306320	2-D3	SP-349925A	11-13						
ED-306320	2-D4	SP-349925C	11-13B						
ED-329056	2-D2	SP-358485J	10-3A						
ED-348205	3-D6	SP-358485K	10-3B						
ED-355605	3-D4	SP-358485L	10-3C						
ED-356421	3-D5	TA-358473B	10-10						
ED-356424	3-D1	TA-358475	10-9						
	to D3	ZG-360943	11-12						
EF-311839	9-F1A	ZS-308846	10-4						
EF-311839	9-F2	ZS-321279	10-7						
EF-326639	2-F3A	ZS-331567	10-2						
EF-326639	2-F4A	ZS-346742	10-8						
EF-602550	9-F1B	ZS-498273	11-7x						
EF-623125	2-F3B								
EF-623125	2-F4B								
EI-337228	3-IC1								
EI-344764	4-IC1								
EI-352644	2-IC1								
EJ-329610	10-5								
EJ-336904	4-J1								
EJ-337405	10-J901								
EJ-343365	6-J1								
EJ-343365	6-J2								
EJ-348218	10-11								
EJ-349401	8-TM902								
EJ-358535	7-J1								
EO-337880	2-L1								
ER-200746	2-FR2								
ER-308028	2-R12								
ER-308875	2-R10								
ER-308875	2-R11								
ER-318647	2-FR3								
ER-318647	2-FR4								
ER-323074	2-R18								
ER-323074	2-R22								
ER-325269	2-R7								
ER-328082	2-R15								
ER-328082	2-R17								
ER-328082	2-R21								
ER-328278	2-RF1								
ER-333355	2-R9								
ER-333598	3-R15								
ER-333598	3-R16								
ER-353214	2-R16								
ER-353214	2-R20								
ER-355214	4-R7								
ER-355633	2-R19								
ES-337902	9-SW1								
ES-349070	10-SW901								
ES-358537	5-SW1								
ES-358555	2-SW1								
ES-358556	2-SW2								
ET-310148	2-TR1								
ET-322598	2-TR2								
EV-358539	3-VR1								
EV-358541	3-VR3								
EV-358541	3-VR4								
EV-358563	3-VR2								
EW-354514	10-6C								
EW-354515	10-6A								
EW-354625	10-6B								
SA-332850	10-1								
SK-343017C	11-6								
SK-343017F	11-6B								

AKAI ELECTRIC CO., LTD.

12-14, 2-Chome, Higashi-Kojiya, Ohta-Ku, Tokyo, Japan

TEL: Tokyo (742) 5111 CABLE: HIFIAKAI TOKYO TELEX: J26261

Printed No. 850522-K1-1700 Printed Date: June 12, 1985

350 Printed in Japan

AKAI

MODEL AM-A101

SCHEMATIC DIAGRAM AND PC BOARD

STK4151II

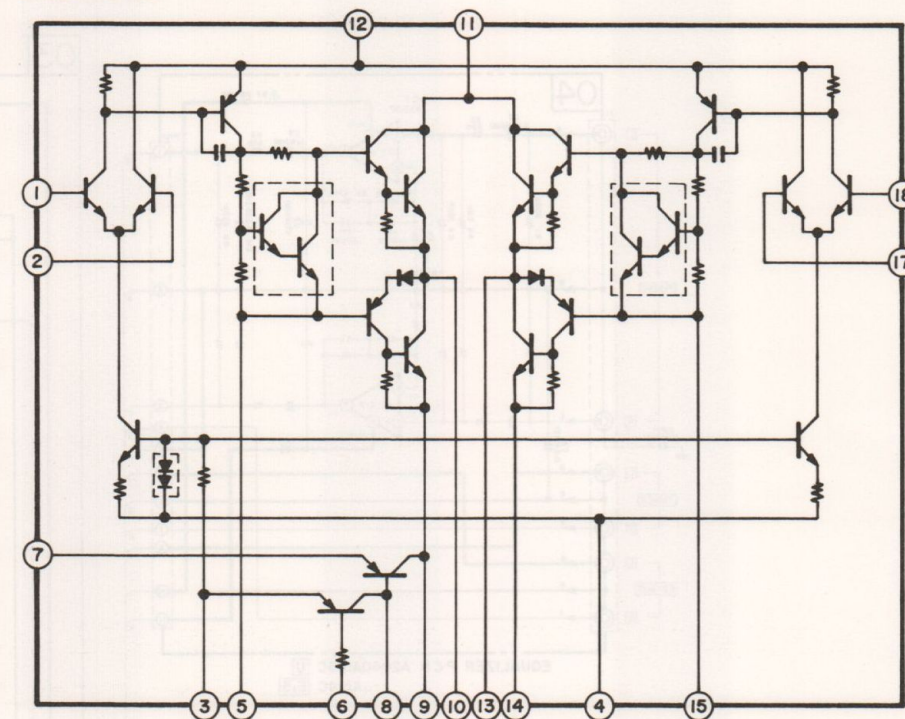
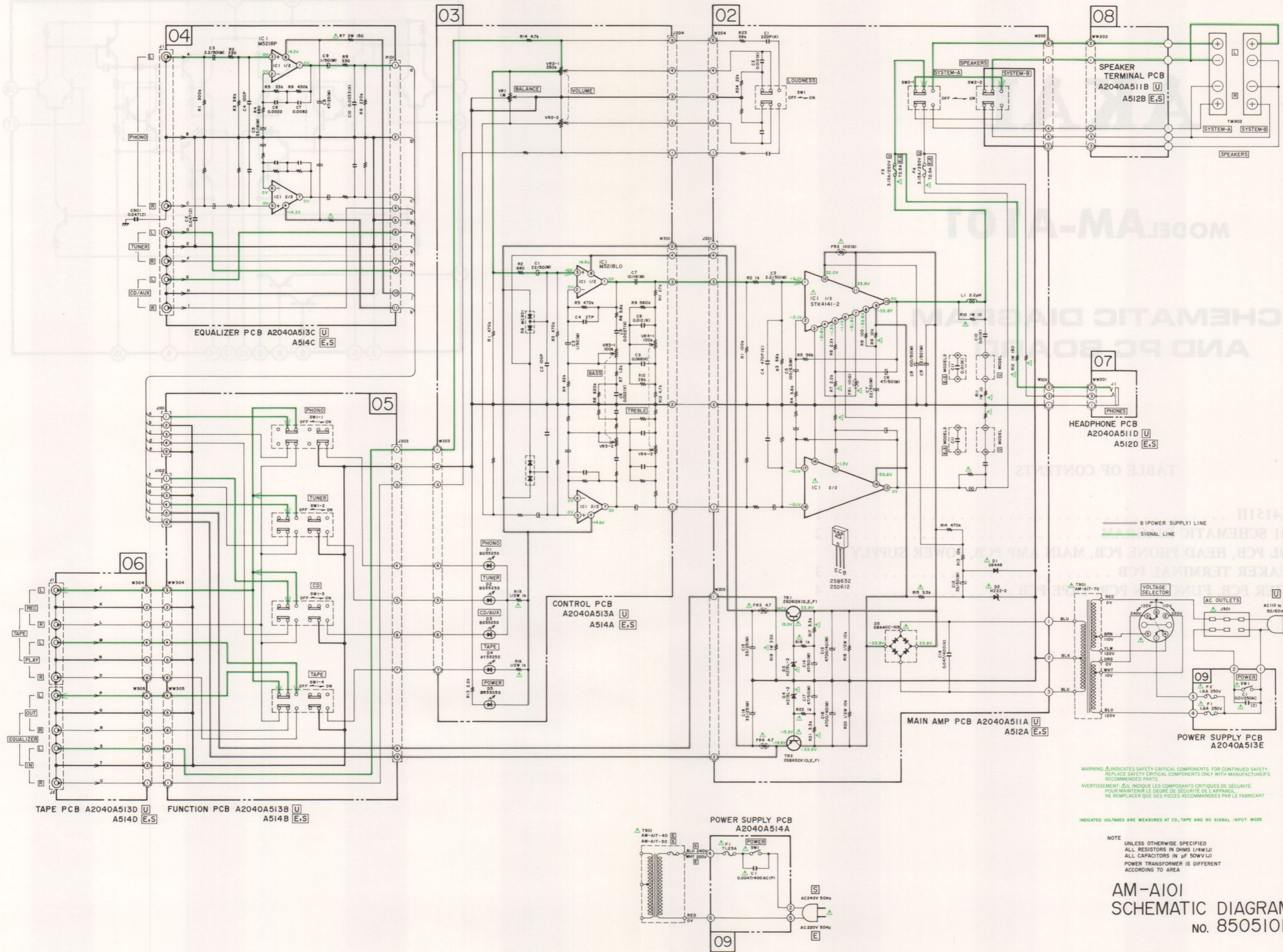

TABLE OF CONTENTS

1. IC'S STK4151II	1
2. AM-A101 SCHEMATIC DIAGRAM	2
3. CONTROL PCB, HEAD PHONE PCB, MAIN AMP PCB, POWER SUPPLY PCB, SPEAKER TERMINAL PCB	3
4. EQUALIZER PCB, FUNCTION PCB, TAPE PCB	4



WARNING: ⚠ INDICATES SAFETY CRITICAL COMPONENTS FOR CONTINUED SAFETY. REPLACE SAFETY CRITICAL COMPONENTS ONLY WITH MANUFACTURER'S RECOMMENDED PARTS.
 AVERTISSEMENT: ⚠ IL INDIQUE LES COMPOSANTS CRITIQUES DE SÉCURITÉ. POUR MAINTENIR LE DEGRÉ DE SÉCURITÉ DE L'APPAREIL, NE REMPLACER QUE DES PIÈCES RECOMMANDÉES PAR LE FABRICANT.

NOTE: UNLESS OTHERWISE SPECIFIED, ALL RESISTORS IN OHMS (R/W/J), ALL CAPACITORS IN µF (50W/J). POWER TRANSFORMER IS DIFFERENT ACCORDING TO AREA.

**AM-A101
 SCHEMATIC DIAGRAM
 No. 850510B**

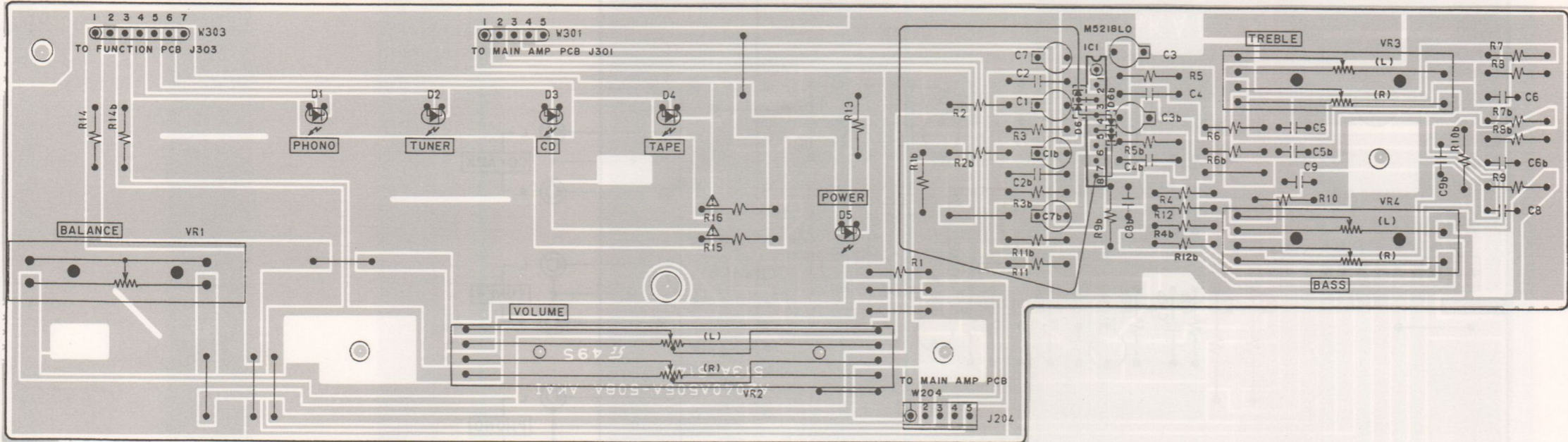

CONTROL PCB A2040A513A U
514A E,S

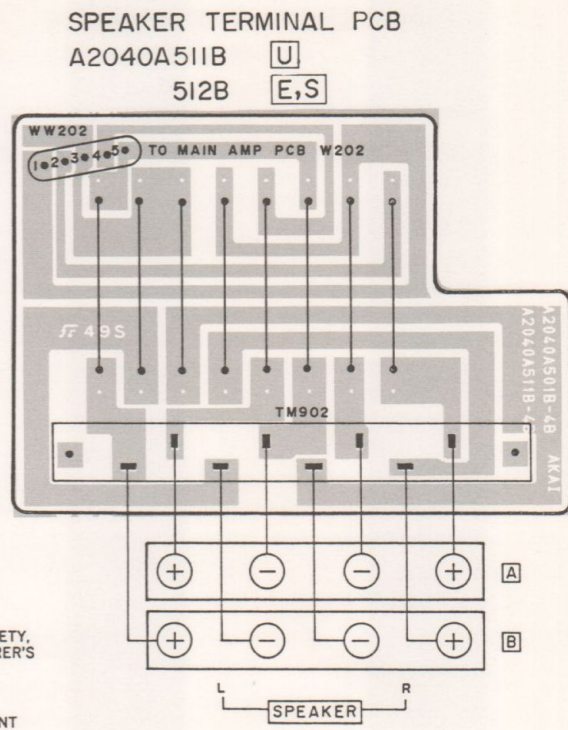

SPEAKER TERMINAL PCB
A2040A511B U
512B E,S

WARNING: Δ INDICATES SAFETY CRITICAL COMPONENTS. FOR CONTINUED SAFETY, REPLACE SAFETY CRITICAL COMPONENTS ONLY WITH MANUFACTURER'S RECOMMENDED PARTS.
 AVERTISSEMENT: Δ IL INDIQUE LES COMPOSANTS CRITIQUES DE SÉCURITÉ. POUR MAINTENIR LE DEGRÉ DE SÉCURITÉ DE L'APPAREIL, NE REMPLACER QUE DES PIÈCES RECOMMANDÉES PAR LE FABRICANT.

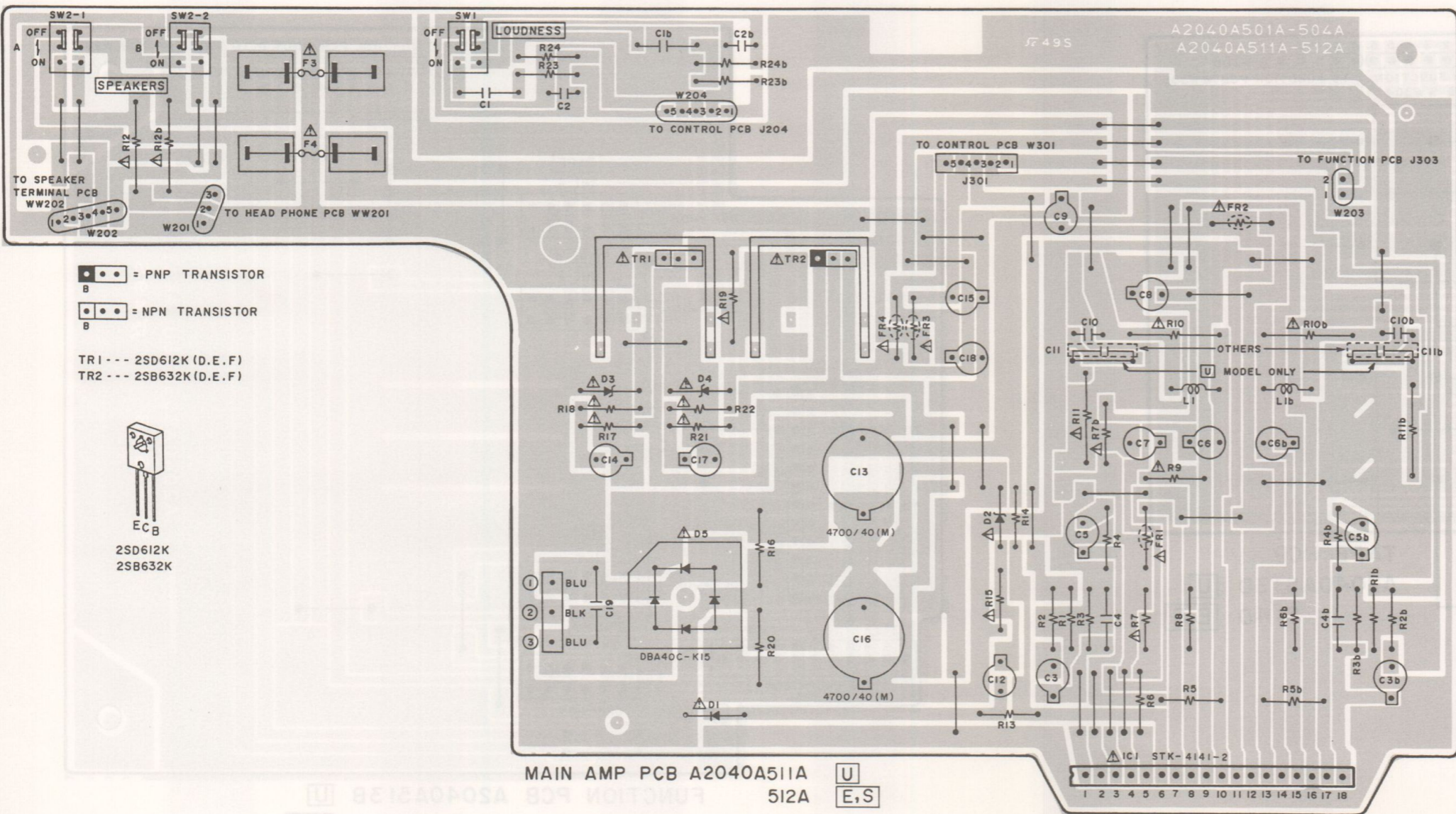

MAIN AMP PCB A2040A511A U
512A E,S

- \bullet = PNP TRANSISTOR
- \square = NPN TRANSISTOR
- TR1 --- 2SD612K (D.E.F)
- TR2 --- 2SB632K (D.E.F)

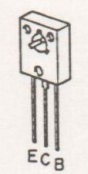

ECB
2SD612K
2SB632K

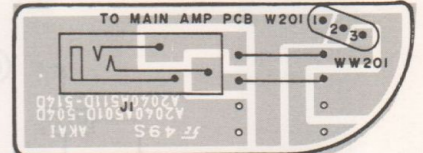

HEADPHONE PCB
A2040A511D U
512D E,S

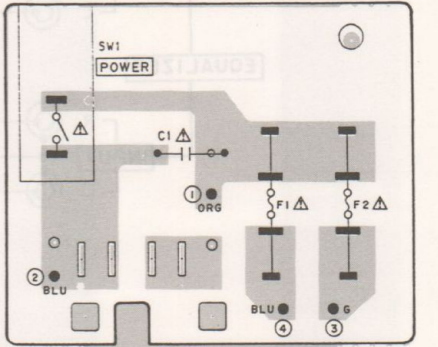

POWER SUPPLY PCB
A2040A513E U

